

**Control Module  
Instruction Manual**

**Control Module  
For  
Flash Microcomputer Programmer**

**NET IMPRESS  
(MegaNETIMPRESS/C"arNETIMPRESS)**

**FO909**

.....8 HG-BG, <H7 CFDCF5 HCB

**FO909**  
**Instruction Manual**  
**No. M2390QU-01**

**Revision History**

<b>Edition</b>	<b>Date of issue</b>	<b>Description</b>
First Edition	December 14, 2009	Initial publication

- (1) No part of this manual may be reproduced, transmitted or transcribed in any form or by any means, without the express written permission of DTS INSIGHT CORPORATION.
- (2) Information in this document may be changed without notice for purposes of improvement and does not represent a commitment on the part of ~~ÖVÜÁÐ ÛÖP VÁÖUÛÛÛÛÖVÖP~~.
- (3) Please contact us if you would find unclear points, questions or errors regarding the information of this document.
- (4) ~~ÖVÜÁÐ ÛÖP VÁÖUÛÛÛÛÖVÖP~~ assumes no responsibility for any damages arising from the use or inability to use this document, or results of using the control module.

© 2009 ~~ÖVÜÁÐ ÛÖP VÁÖUÛÛÛÛÖVÖP~~. All Rights Reserved.  
Printed in Japan

## **Contents**

<b>Revision History .....</b>	<b>i</b>
<b>1 Overview .....</b>	<b>1</b>
<b>2 Specifications.....</b>	<b>2</b>
2.1 Target Microcomputer and Specifications.....	2
2.2 Setting Up Specific Parameters.....	3
2.2.1 Parameter Table1 Tab.....	3
2.2.2 Basic Operation Tab.....	8
2.2.3 Parameter Table 2 Tab.....	11
2.3 Device Functions and Their Operation.....	12
<b>3 Security Function.....</b>	<b>13</b>
3.1 Disabling Security [FUNC 81].....	13
3.2 Setting Security Bit [FUNC 82] .....	13
<b>4 Profile Data Display Function .....</b>	<b>19</b>
4.1 Operation Procedure for Display Function .....	19
4.2 Displaying Profile Data .....	19
<b>5 User ID Check Function.....</b>	<b>20</b>
<b>6 Error Message .....</b>	<b>21</b>
<b>7 Connecting to the Target System and Connector .....</b>	<b>15</b>
7.1 Signal List .....	15
7.2 Model Connection to Target System.....	16
7.3 Waveform of Control Signal.....	18
7.4 Probe .....	20
<b>8 Adapting to Derivative Microcomputers - Modifying Parameters - .....</b>	<b>21</b>
8.1 Minor Parameter Modification through the Keyboard of NET IMPRESS .....	21
8.2 Modifying Parameters for Target Microcomputer using the Remote Controller .....	21
8.3 How to Modify Parameters Using Remote Controller Software (AZ490).....	22
<b>9 Replacing Definition Program.....</b>	<b>23</b>
9.1 Overview .....	23
9.2 How to Replace Definition Program .....	24
<b>10 Notes and Cautions for Using Control Module .....</b>	<b>25</b>
<b>11 Appendix.....</b>	<b>26</b>

---

## 1 Overview

---

The FO909 is the Control Module for MegaNETIMPRESS or C"arNETIMPRESS (collectively "NET IMPRESS"), the advanced on-board flash microcomputer programmer.

The Control Module FO909 supports programming the flash ROM inside Oki Semiconductor ML22Q573 and other equivalent flash microcomputers that have the same programming algorithm and protocol as Oki Semiconductor ML22Q573.

The Control Module FO909 consists of the Compact Flash Card containing the programming control software.

The free area of the Compact Flash Card can be used as the DOS file area to temporarily store your object file created on the host computer.

The Control Module FO909 is available in three types for your choice: /P128, /D128, and /D512. Choose an appropriate type according to capacity of the Compact Flash Card. /P128 and /D128 support up to 128 Mbyte of the Compact Flash Card, and /D512 is for up to 512Mbyte.

With the D type, you can switch between YIM folders in the Control Module.

JTAG Adapter (AZ473) is required as the communication interface between NET IMPRESS main unit and a target system for this product.

For the JTAG adapter, contact your local distributor or us.

### **NOTES:**

With the Control Module FO909, you can program microcomputers built in flash memory which have the same programming algorithm and protocol as the virtual target microcomputer.

For modifying parameters, see Chapter 8 of this manual.

Check once again if your microcomputer is supported by the Control Module FO909, or if your microcomputer has the same algorithm and protocol as those of the target microcomputer.

Using this product to microcomputers which are not supported may destroy the microcomputer and a user system.

The Control Module FO909 is designed to support programming microcomputers of a wide range and you can program a microcomputer of different programming voltage ( $V_{pp}$ ) by changing parameters.

Be sure to have good understanding on signal connection by carefully reading Chapter 7 "Connecting to the Target System and Connector" before you use the Control Module.

Check the item below.

- (1) Is the microcomputer you are about to use listed on the supported microcomputer list of the Control Module?

Contact your local distributor or us for any questions or unclear points.

---

## 2 Specifications

---

### 2.1 Target Microcomputer and Specifications

For any items that are not specifically described here, the standard specifications of the NET IMPRESS are applied.

Control Module	FO909
Target Microcomputer	Defined by Micom Packs FO909Mxx *1
User Flash Memory Capacity	Same as above *1
User Flash Memory Address	Same as above *1
Programming Voltage (Vpp)	Not applied
Default	—
Vccp (Minimum voltage during programming)	—
Object File Format	Intel HEX Motorola S Binary
Default	Motorola S
Target Interface	JTAG Interface *2 5 Mbps/ 3.3 Mbps/ 2.5 Mbps/ 1.25 Mbps
Data Transfer Format between Flash Microcomputer Programmer and Target System	Binary
Memory status when erased	#FF
MCU Clock during programming	—
Voltage of target interface during programming	Defined by Micom Packs FO909Mxx *1

\*1: For details, please refer to the instruction manual of the Micom Pack.

\*2: The signals from NET IMPRESS are converted to JTAG signals by using a JTAG Adapter (AZ473). See section 2.2.1 (7) for the setting of baud rate.

## 2.2 Setting Up Specific Parameters

Make the initial setup by using AZ490, the remote controller running on Windows. For the operating instructions of AZ490, see the AZ490 Instruction Manual.

### 2.2.1 Parameter Table1 Tab

Set up the parameters for your target microcomputer with the Parameter Table1 tab.

The screenshot shows the 'Remote Control Mode' software interface, Version 5.60. The 'Current IMPRESS Module' is 'FO909.YIM'. The 'MCU TYPE' is 'FO909', 'MODEL CODE' is 'FO909', 'MICOM PACK No.' is 'FO909Mxx', and 'Port No.' is 'TCP/IP'. The 'Parameter Table 1' tab is active, showing various configuration parameters:

- MCU Type (FUNC D8):** FO909
- TVcc Threshold (FUNC D3):** 2.7 [V]
- Flash ROM (FUNC D6):**
  - First Address: 00000000
  - Last Address: 0007FFFF
- ROM Block Configuration:**

Group No.	Start Address	Block Size (byte)
Group 1	00000000	00002000
Group 2		
Group 3		
Group 4		
Group 5		
Group 6		
Group 7		
Group 8		
Group 9		
Group 10		
Group 11		
Group 12		
Group 13		
Group 14		
- MCU Clock Frequency (FUNC DF):** 1.0 [MHz]
- MCU Operation Mode (FUNC D4):** 0000
- WDT Clock Period (FUNC D5):** 20 [ms]
- Data Communication:**
  - Interface (FUNC D1):**  UART  CSI
  - Channel No. (FUNC D7):**  0  1  2  3
  - UART Baud Rate (FUNC D2):** 2400
  - CSI Baud Rate (FUNC D9):** 5M
  - BufferRAM Initialize Mode (FUNC 9A):** KEEP
  - SUM Check Mode (FUNC 9C):** 8/8bit

On the right side, there are control buttons: REMOTE (selected), EDIT, Communication Check, 10KEY, Select Module, Execute YMN, Save to HD, OK, Cancel, Exit, and a Version section showing Remote Control 5.60, Control Module 12.00, and Firmware 12.53.

### **(1) TVcc Threshold [ FUNC D 3 ]**

Set up a value about 10% lower than the minimum operation voltage of the target microcomputer. NET IMPRESS senses the operation voltage (TVcc) of the target microcomputer and executes the Device Functions when the TVcc gets higher than the specified value.

For the operation procedure to set up TVcc threshold on the NET IMPRESS main unit, see the MegaNETIMPRESS/C"arNETIMPRESS Instruction Manual at section 5. 4. 5 "TVcc Threshold Setting".

### **(2) Flash ROM (First Address, Last Address) [FUNC D6]**

Set up the flash memory area (First Address, Last Address) built in the microcomputer.

You cannot set up flash ROM for NET IMPRESS and this is only for display.

For details, see the MegaNETIMPRESS/C"arNETIMPRESS Instruction Manual, section 5. 4. 8 "Flash Memory Area Display".

### **(3) ROM Block Configuration**

Set up the block configuration of flash memory.

<Block Data Table>

The block data table consists of information of three kinds: Group No., Start Address and Block Size.

Group No: You can specify up to 14 groups (Group1 to Group 14). A block group consists of memory blocks that have the same one block size on linear address. Group number is determined by the address order starting from lower address.

Start Address: A starting address of a block group.  
The flash memory of the size specified in the Block Size sequentially continues, forming one block group.

Block Size: NET IMPRESS understands that the flash memory blocks of a size specified in the Block Size are placed sequentially until a next block group address.

Set the block start address and the block size to "0" at the last block.

Example:

Group No.	Start Address	Block Size
1	#00F80000	#00008000
2	#00FA0000	#00010000
3	#00000000	#00000000

Block Start Address

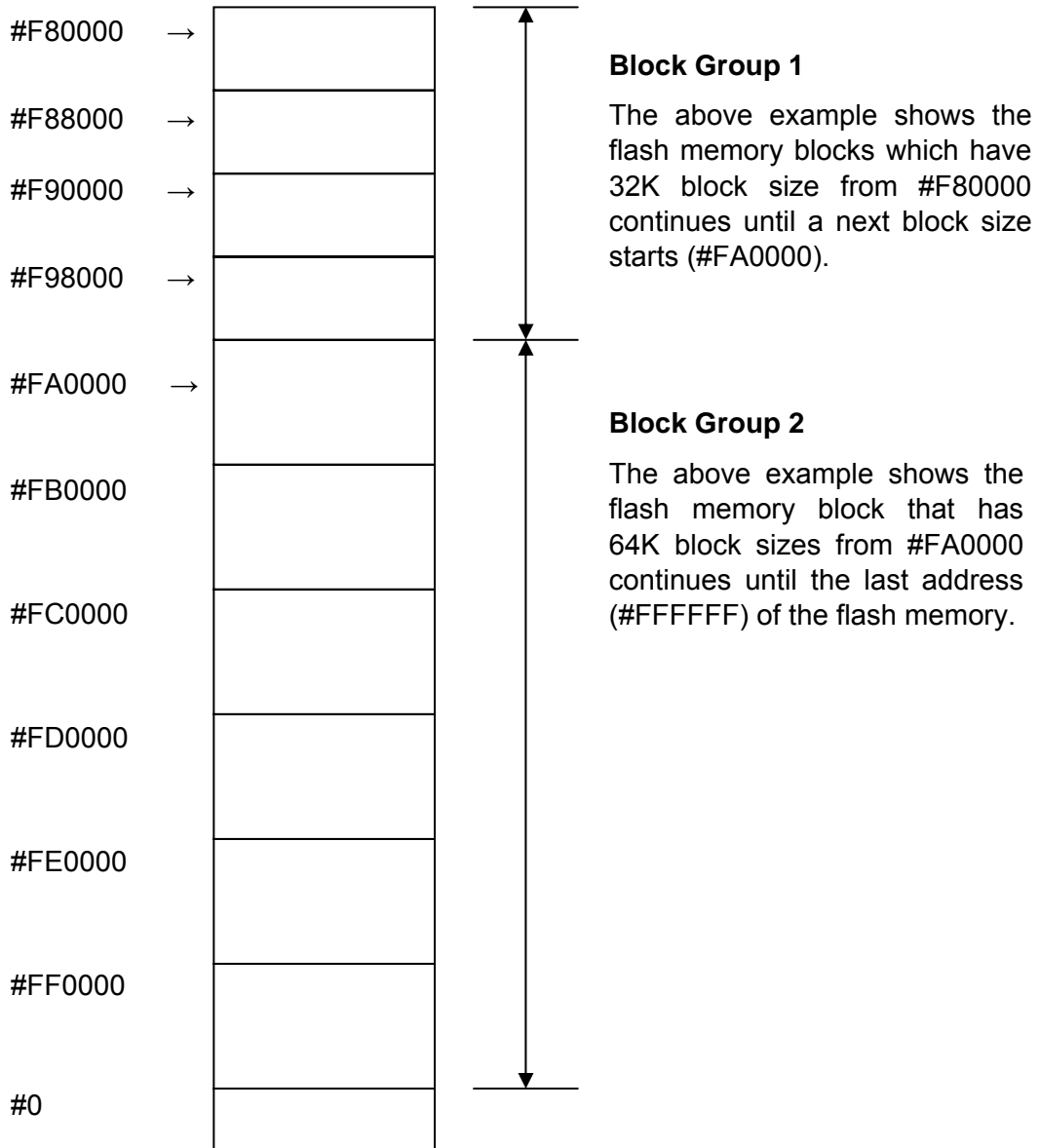

**Block Group 1**

The above example shows the flash memory blocks which have 32K block size from #F80000 continues until a next block size starts (#FA0000).

**Block Group 2**

The above example shows the flash memory block that has 64K block sizes from #FA0000 continues until the last address (#FFFFFF) of the flash memory.



#### (4) MCU Clock Frequency [ FUNC D F ]

Sets up the operation clock of the target microcomputer.

This setting is not required with FO909.

#### (5) MCU Operation Mode [FUNC D 4]

Enables/disables the security function automatically during execution of Device Function.

Disabling security automatically... The security function is automatically disabled when the Device Function including erasing all area is executed.

Enabling security automatically...The security function is automatically enabled after programming is completed when the Device Function including "Program" is executed. \*1

\*1: See section 2.3 for the details.

Automatic Security	NET IMPRESS	Remote Control Software
OFF (default)	Opt	0000
ON	St'd	0001

\*Please refer to Chapter 3 for the details of security function.

#### (6) WDT Clock Period [FUNC D 5]

NET IMPRESS has the function to output periodic clock pulses during programming. To use this function, it is required to setup the WDT Clock Period.

The periodic clock pulse is output from the WDT signal (No. 15 pin) that is listed in the target probe signal list of section 7.1 "Signal List".

See the MegaNETIMPRESS/C"arNETIMPRESS Instruction Manual, section 5.5.7 "Set Watch Dog Timer" for setting the WDT signal with NET IMPRESS.

## **(7) Data Communication**

This is the field to make communication settings between the JTAG adapter and the target microcomputer. For the FO909, make the settings as follows.

- **Communication Channel [FUNC D 1]**

Not being used

- **Channel No. [ FUNC D 7 ]**

Not being used

- **UART Baud Rate [ FUNC D 2 ]**

Not being used

- **CSI Baud Rate [ FUNC D 9 ]**

This setting is reflected to the baud rate of the JTAG communication.

Select from: 5 Mbps, 3.3 Mbps, 2.5 Mbps, and 1.25 Mbps

For setting up the CSI baud rate with NET IMPRESS, see the MegaNETIMPRESS/C"arNETIMPRESS Instruction Manual, section 5. 5. 4. "Set CSI Baud Rate".

## **(8) MCU Type [ FUNC D 8 ]**

The setting here will be displayed in the MCU Type field located at the top left of the Remote Control Mode window and the NET IMPRESS main unit.

You can enter any characters up to 16 characters such as microcomputer's model name or device name you are using.

## **(9) OK**

By clicking this OK button, you can send the settings on the Parameter Table 1 tab into the Control Module. Be sure to click the OK button before moving to other tabs so that you can make the changes of (1) – (8) valid. If you do not click the OK button, the changes will not be sent to the Control Module.

## 2.2.2 Basic Operation Tab

With the Basic Operation tab, you have the three features to work with as described below.

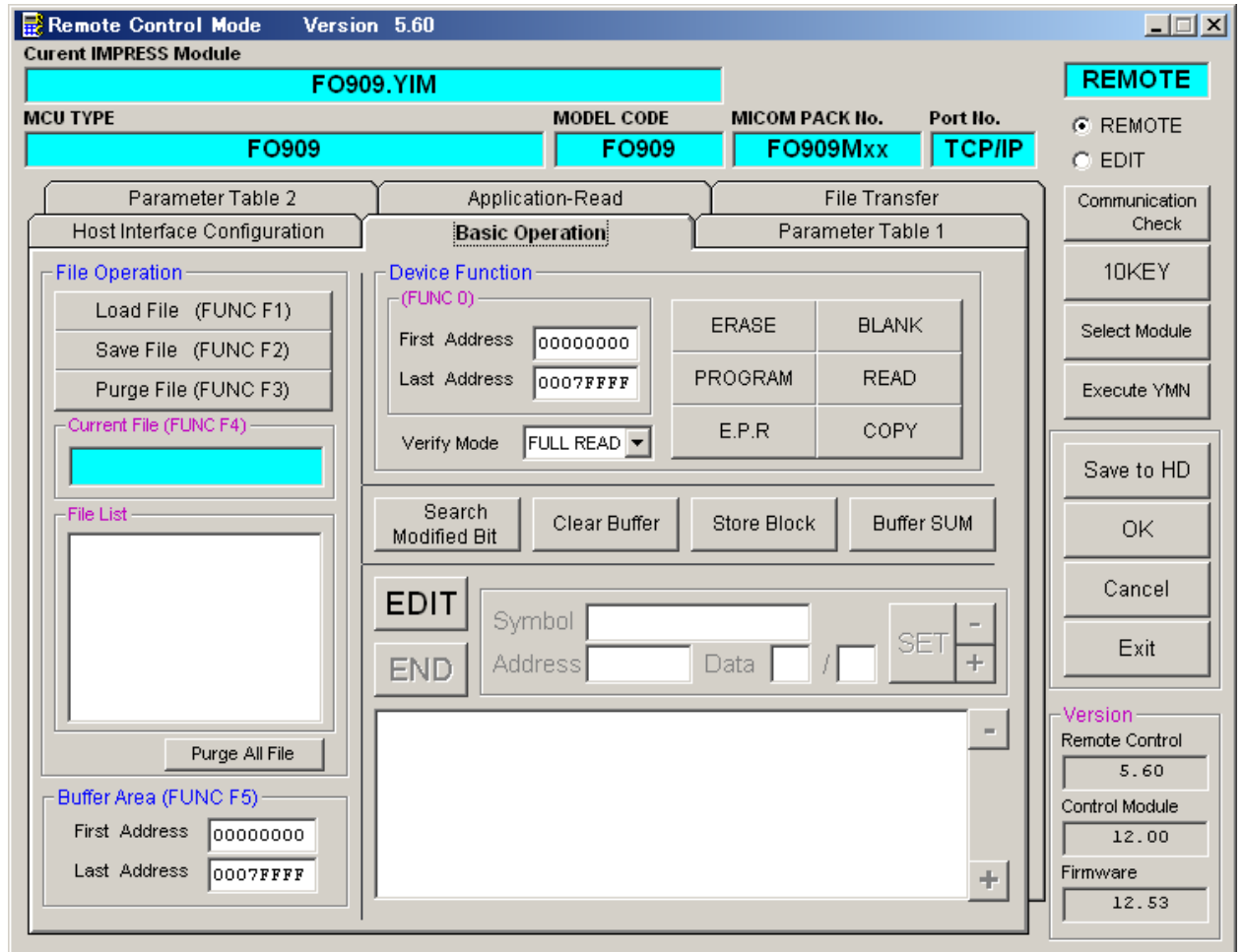

### **(1) Device Function [FUNC 0 ]**

Set up a target area to execute the Device Functions such as reading, programming, etc.

Normally, set up the same area as those you set up for the Flash ROM as described in the Section 2.2.1 (2).

The Device Function Address [FUNC 0] is automatically aligned with the block boundary address of the flash memory by its specified address as shown in Figure 2-1. The Device Functions will be executed to this automatically aligned area.

### **(2) Buffer Area [FUNC F 5 ]**

Set up an area to save and load the data on the buffer memory of NET IMPRESS (when you have a binary file). Normally, set the same areas as those for the Flash ROM as described in the Section 2.2.1 (2).

Figure 2-2 shows how the Device Function [FUNC 0], Buffer Area [FUNC F 5] and Flash ROM Area [FUNC D 6] relate with each other.

### **(3) OK**

Click this OK button to send the settings on the Basic Operation tab into the Control Module. When you made changes to the above (1) and (2) settings, be sure to click the OK button before moving to other tabs. If you do not click the OK button, the changes will not be reflected.

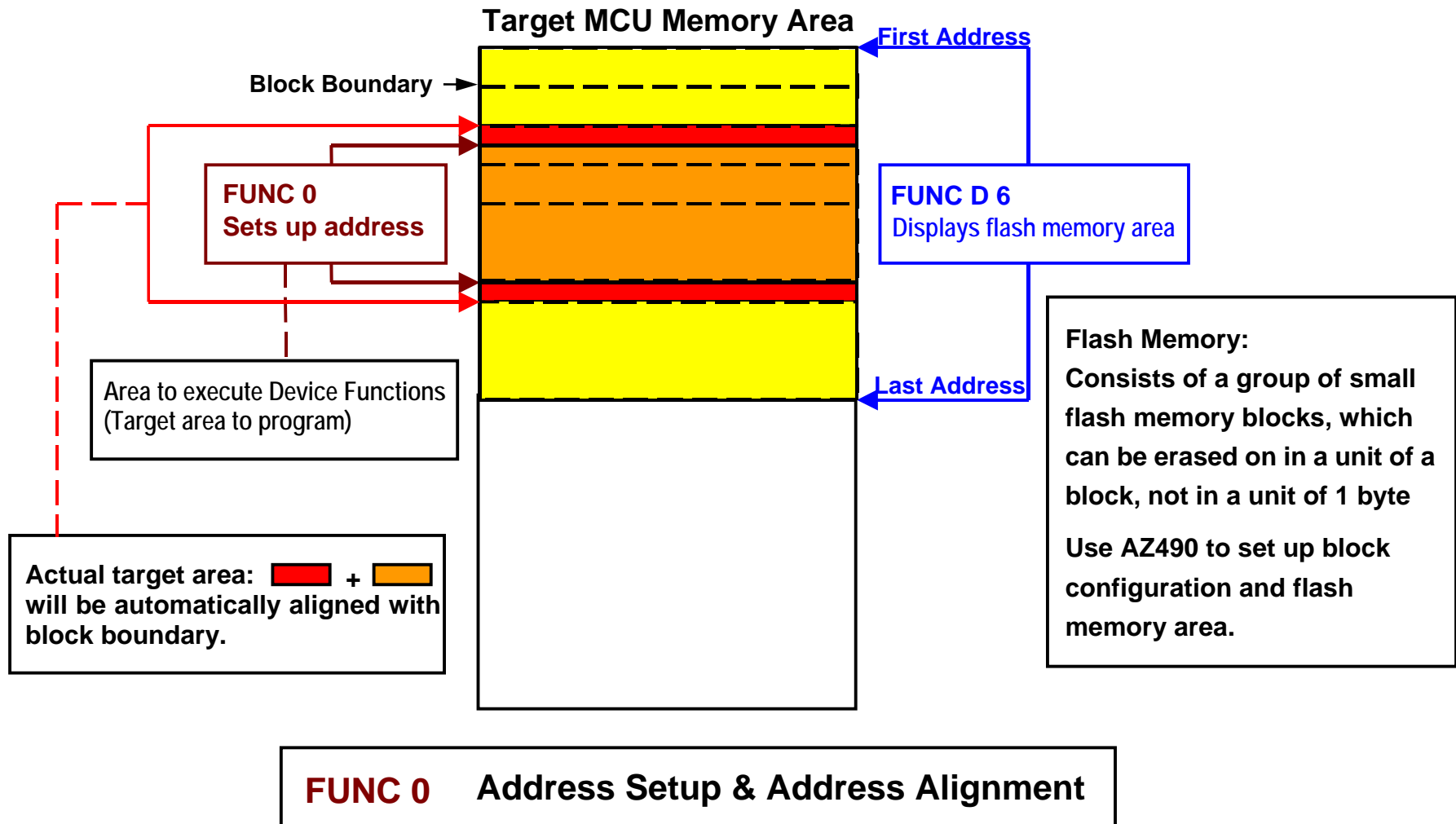

Figure 2-2-2-1

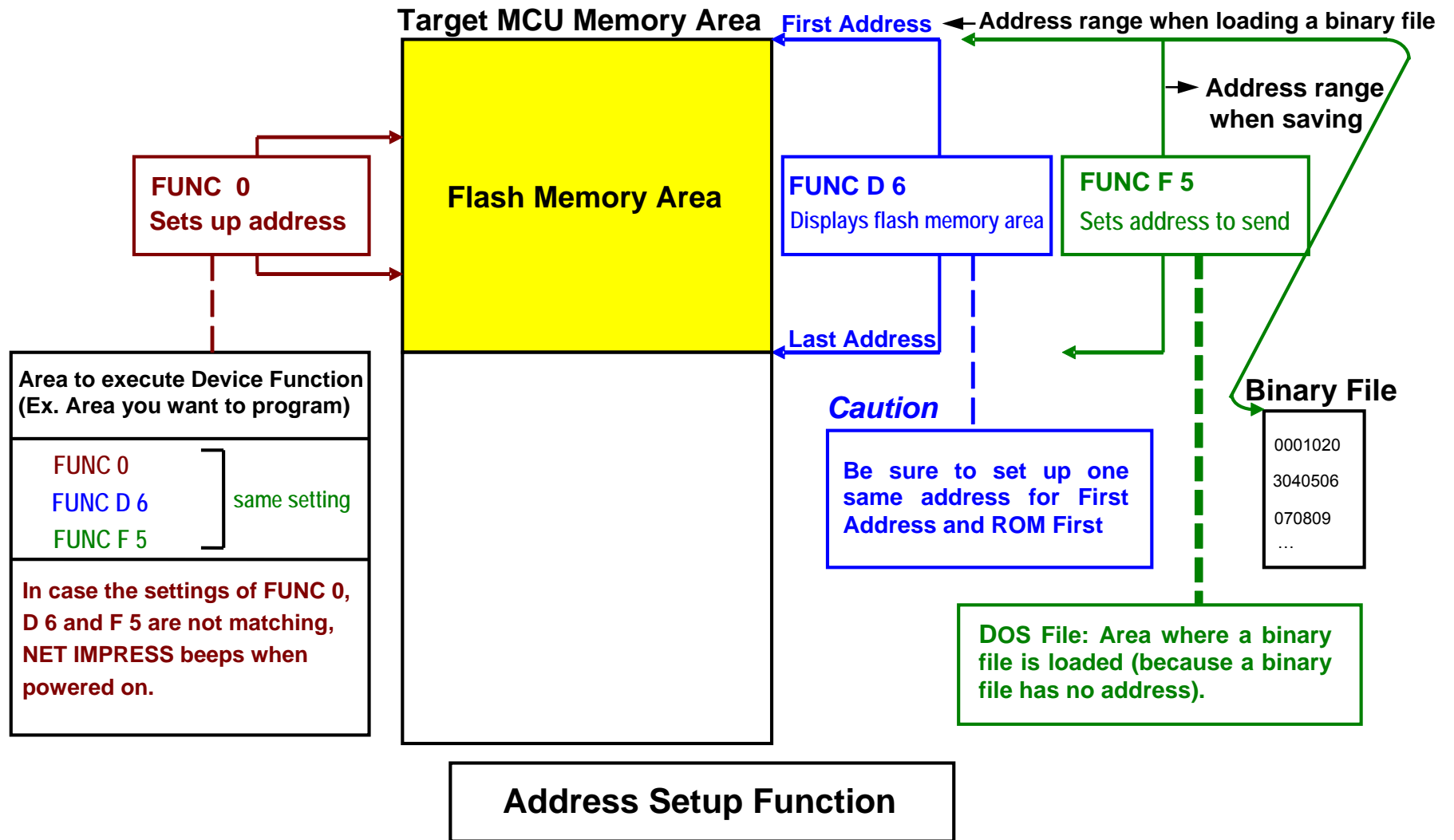

Figure 2- 2-2-2

### 2.2.3 Parameter Table 2 Tab

The Parameter Table 2 tab contains the parameters specific to the microcomputer. Therefore, be sure not to change any value in this window.

**In case you need to change the settings, be sure to consult our support center in advance.**

Remote Control Mode Version 5.60

Current IMPRESS Module: **FO909.YIM**

MCU TYPE: **FO909**    MODEL CODE: **FO909**    MICOM PACK No.: **FO909Mxx**    Port No.: **TCP/IP**

Host Interface Configuration    Basic Operation    Parameter Table 1

**Parameter Table 2!**    Application-Read    File Transfer

Specific Parameter for this Control Module (FUNC 8X)

	00	01	02	03	04	05	06	07	08	09	0A	0B	0C	0D	0E	0F
0C0:	8A	00	00	00	00	00	00	00	00	00	00	00	00	00	00	00
0D0:	00	64	03	E8	00	FA	00	FA	00	01	00	00	00	00	00	00
0E0:	00	00	00	00	00	00	00	00	00	00	00	00	00	00	00	00
0F0:	00	00	00	00	00	00	00	00	00	00	00	00	00	00	00	00
140:	00	00	00	00	00	00	00	00	00	00	00	00	00	00	00	00

**- WARNING -**

**These parameter should not be changed.  
Contact to YDC in details.**

Version: Remote Control 5.60, Control Module 12.00, Firmware 12.53

## 2.3 Device Functions and Their Operation

The table below lists the operations to the flash memory that are executed when NET IMPRESS starts the Device Functions.

Device Function		ERASE	BLANK CHECK	PROGRAM	READ	E.P.R	COPY
Target Memory Area	A partial areas of flash memory by [FUNC 0] command (with Block Alignment)	Executed	Executed	Executed	Executed	Executed	Executed
	Entire area of flash memory by [FUNC D6] command	Executed	Executed	Executed	Executed	Executed	Executed
Operation executed to Flash Memory		<input checked="" type="checkbox"/> Erase *1 <input checked="" type="checkbox"/> Blank	<input checked="" type="checkbox"/> Blank	<input type="checkbox"/> Erase <input type="checkbox"/> Blank <input checked="" type="checkbox"/> Program <input checked="" type="checkbox"/> Read *1	<input checked="" type="checkbox"/> Read	<input checked="" type="checkbox"/> Erase <input type="checkbox"/> Blank <input checked="" type="checkbox"/> Program <input checked="" type="checkbox"/> Read *1	<input checked="" type="checkbox"/> Copy <input checked="" type="checkbox"/> Read

\*1: This control module executes Full Read Verify regardless of the Read Mode setting by the Read Mode Switch-over (FUNC 99). The Read Verify operation that is executed by the Device Functions, Erase, E.P.R, and Program, can be switched to execute/not execute by FUNC 85.

<Setup operation on NET IMPRESS>

Press    keys.

Use the Down Arrow or Up Arrow key   to choose the operation mode.

Press    keys to fix the choice.



---

## 3 Security Function

---

The target microcomputer to be programmed by FO909 has security function.



By using this security function, you can guard against illegal writing and reading of data.



### 3.1 Disabling Security [FUNC 81]

Clears Security bit.

Please note that when you disable the security function, it also forces a complete erase of flash memory.

<Setup operation on NET IMPRESS>

Press    keys.

Use the Down Arrow or Up Arrow key   to choose the operation mode.

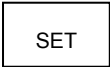
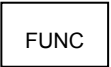

Press    keys to fix the choice.



### 3.2 Setting Security Bit [FUNC 82]



Sets Security bit.

By setting Security bit, read data value of flash memory will be illegal.

<Setup operation on NET IMPRESS)>

Press    keys.

Use the Down Arrow or Up Arrow key   to choose the operation mode.

Press    keys to fix the choice.

---

## 4 Profile Data Display Function

---

FO909 has the function to read and display profile data of the target device.

### 4.1 Operation Procedure for Display Function

<Setup operation on NET IMPRESS>

Press 

FUNC
------

8
---

3
---

 keys.

Press 

SET
-----

FUNC
------

SET
-----

 keys to execute the profile data display function.

\*To read profile data from the target device, it is necessary that the target device and NET IMPRESS are wired properly.

### 4.2 Displaying Profile Data

By executing this function, NET IMPRESS accesses the profile register of the target microcomputer and displays the value in hexadecimal.

## 5 User ID Check Function

This function is to check IDs (product ID number, version number, etc.) which are given by users. By using this function, you can guard against illegal writing and reading of data on products which the IDs do not match.

When no xxx.YID file exists, this function is not executed.

You can easily create this file with optional software, KEY File Generator (AZ481).

Note: This function is disabled when the security function is set enabled.

### <Use ID Check Function Process Flow>

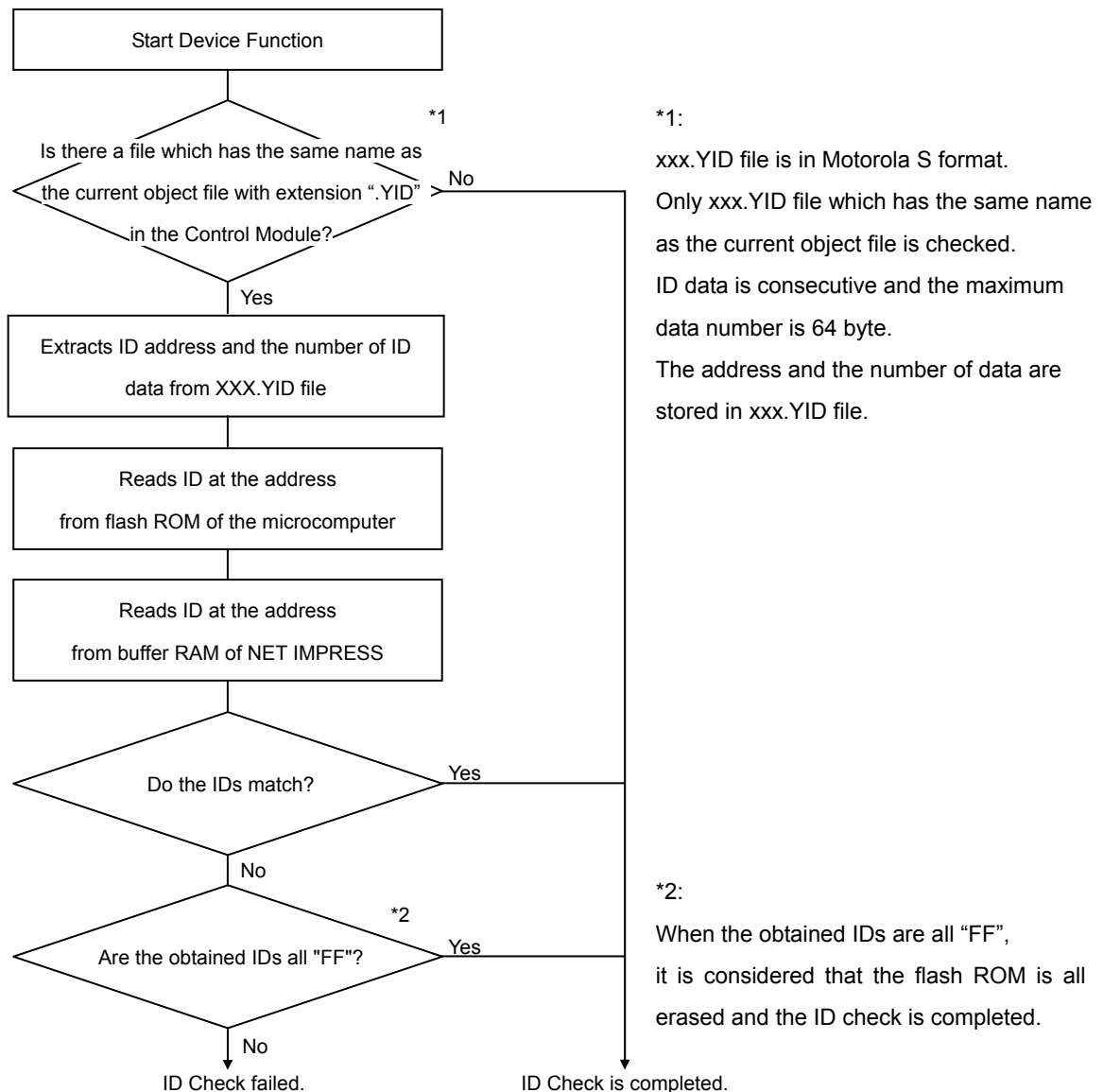

---

## 6 Error Message

---

When executing Device Functions, specific error messages are output if there is incorrect signal wiring or parameter setting.

In this chapter, descriptions of errors and actions to take regarding “1109: DEVICE ERR” are described.

For error messages other than described in this chapter, please refer to the MegaNETIMPRESS/C”arNETIMPRESS Instruction Manual.

“1109: DEVICE ERR” is followed by 2-digit error code.

Error Code	Descriptions
10	Could not go to the flash programming mode.
11	The target microcomputer is not supported by this Control Module.
12	Undefined data exist in profile register.
13	Parameter setting is incorrect.
15	Undefined data exist in profile register.
16	An error occurred during Flash ROM reset.
21	An error occurred during disabling security.
22	Security cannot be disabled.
31	An error occurred during enabling security.
32	Security cannot be enabled.

## 7 Connecting to the Target System and Connector

### 7.1 Signal List

When using this control module, a JTAG adapter (AZ473) is required between the target microcomputer and NET IMPRESS.

Microcomputer	JTAG Adapter AZ473				Microcomputer
TESTI2 (TMS)	TMS	(11)	1	TVpp1	
TESTI1 (nTRST)	/TRES	(12)	2	VCC	
Multiplexer	/TICS0	(13)	3	TMODE	
Multiplexer	/TICS1	(14)	(4)	TVccd	DVDD
Watchdog pulse	WDT	(15)	(5)	GND	DGND
TESTI0 (MODE)	TAUX3	(16)	(6)	TCK	TESTI4 (TCK)
Reserved	TAUX3	17	(7)	GND	DGND
	NC	18	(8)	TDI	TESTI3 (TDI)
	/TSEQ	19	(9)	GND	DGND
DGND	GND	(20)	(10)	TDO	TESTO (TDO)

#### Target Probe Signal List (FO909)

- Be sure to connect the signals marked with “○” to the target system.
- For the signals in parentheses, connect them only when necessary.
- For the signals not marked with “○” or not in parentheses, be sure not to connect them to a circuit of the target system.

## 7.2 Model Connection to Target System

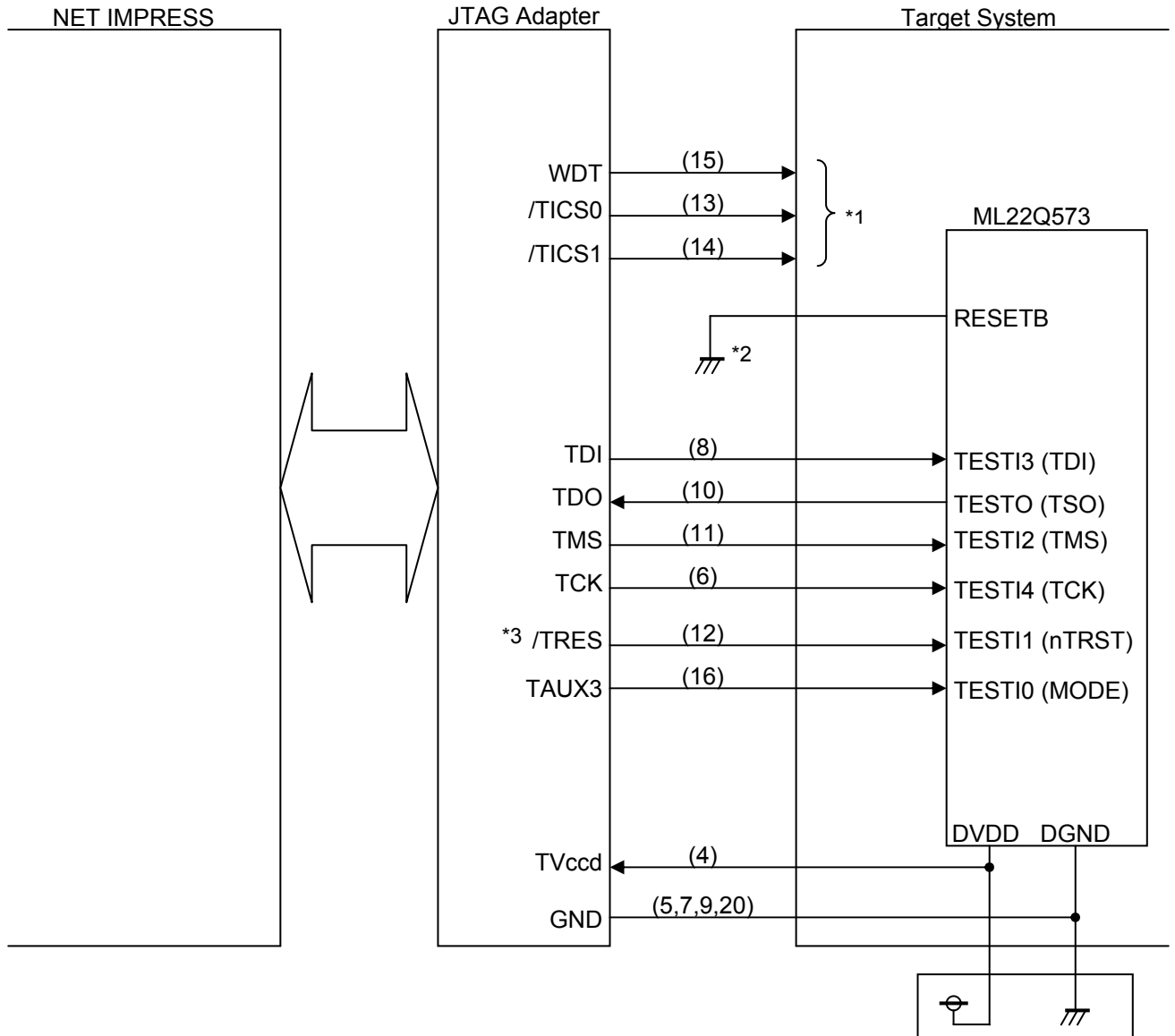

\*1: Optional function

\*2: Have RESETB terminal asserted when executing programming.

\*3: When using pull-down register at TESTI1 (nTRST) on the target circuit, consider that there is 2.7 KΩ pull-up at /TRES on JTAG adapter AZ473.

(1) For the signals defined as shared terminals, multiplexing circuit of these signals must be provided to a target system.

/TICSx signal is asserted only when NET IMPRESS is performing the Device Functions.

/TICSx signal multiplexes signals connected to these shared terminals.

Multiplexing circuits are not required for a target system where these signals for write control are defined as the control signals for the flash microcomputer.

Inserting the multiplexing circuit into a target system can produce the same conditions with a state where NET IMPRESS is not connected (i.e., the connector is unplugged) while /TICSx signal is being negated (when the Device Functions are not executed).

(2) WDT Signal:

The clock signal defined with the WDT Clock Period [FUNC D 5] is constantly output from WDT signal terminal by NET IMPRESS. (Open collector output)

Connect this signal to the user circuit that requires a clock signal when programming the flash memory.

(3) /TRES Signal:

/TRES signal of JTAG adapter is an open collector type output.

(There is 2.7 K $\Omega$  pull up at /TRES by TVccd power input in JTAG adapter.)

### 7.3 Waveform of Control Signal

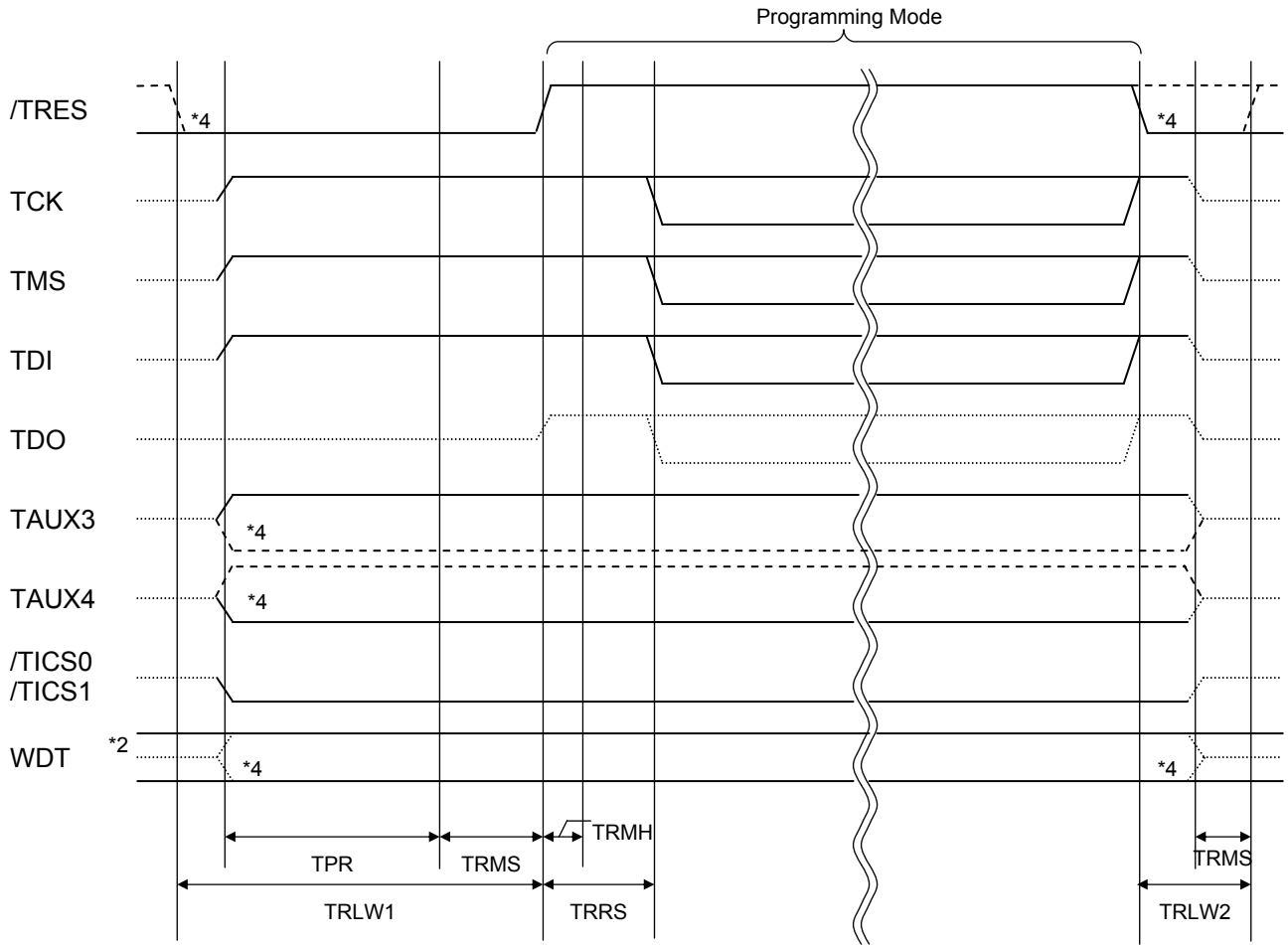

	NET IMPRESS Specification
TPR	200 ms (Minimum)
TRLW1	350 ms (Minimum)
TRLW2	100 ms (Minimum)
TRMS	50 ms (Minimum)
TRMH	5 ms (Minimum)
TRRS	100 ms (Minimum)

\*1: The dotted line " - - - - - " indicates HIZ state.

\*2: WDT is open collector output.

\*3: For input signal to programmer

\*4: Optional function



- (1) Turn on NET IMPRESS first and then a target system. Then, NET IMPRESS asserts /TRES right after its power is turned on. Also it starts outputting periodic pulse of the WDT signal.
- (2) When /TICSx signal is asserted by execution of program command, connect communication channels for programming on a target system to NET IMPRESS. (Multiplexing with this /TICSx signal is not required for a system where communication channel and related signals for programming are exclusively used by NET IMPRESS, independently from other user circuit.)
- (3) The programming mode, upon being executed, starts communicating with NET IMPRESS using a specified communication circuit. Communication is performed in conditions set up in advance.
- (6) When programming completes, NET IMPRESS negates /TICSx.
- (7) NET IMPRESS continues asserting a reset signal even while the Device Functions are not executed. Also, it continues generating periodic pulse of WDT signal.

## 7.4 Probe

JTAG Adapter, AZ473 (optional item) is required to write data on a flash ROM on a user target system by using FO909.

Please consult us or your local distributor for assistance on purchasing AZ473 along with FO909.

### JTAG adapter (NET IMPRESS - JTAG signal conversion adapter)

JTAG adapter converts a standard serial signal of NET IMPRESS to a JTAG signal.

With this adapter, NET IMPRESS can support programming on a flash ROM which employs JTAG protocol.

Configuration with JTAG adapter is shown below.

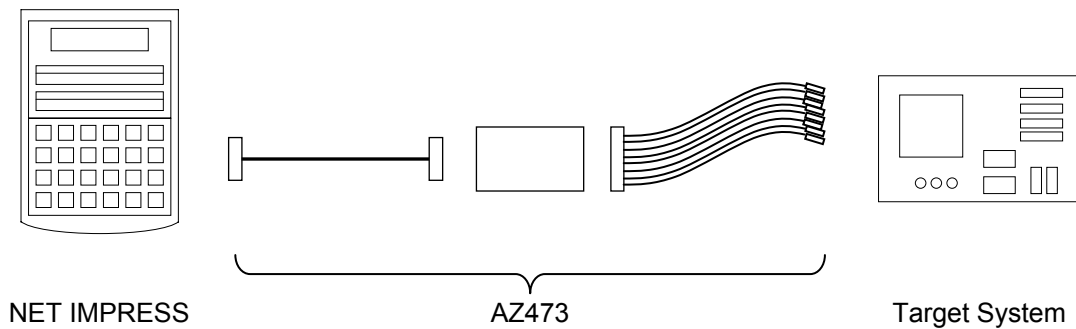

No connector is attached at a user target system side of JTAG adapter.

It is required to attach a connector suitable for your target system.

---

## 8 Adapting to Derivative Microcomputers - Modifying Parameters -

---

### 8.1 Minor Parameter Modification through the Keyboard of NET IMPRESS

For the parameters that are defined by the function commands (FUNCTION D1 to FUNCTION DF) as described in section 5.5 “Parameters Settings” of the MegaNETIMPRESS/C”arNETIMPRESS Instruction Manual, you can modify them through the keyboard of NET IMPRESS. Parameters for communication interface with a target system, voltage of a target system, etc., for example, are included in those you can modify through the keyboard of NET IMPRESS.

**IMPORTANT:**

You cannot modify wide-ranging parameters and settings of the target microcomputer such as ROM block configuration of flash ROM address (FUNCTION D6) through the keyboard of NET IMPRESS. For modifying them, it is recommended to use the Remote Controller AZ490 that is available for an additional order.

Also, the parameter list of actual microcomputers is available at our Web site. For details, contact your local distributor or us.

### 8.2 Modifying Parameters for Target Microcomputer using the Remote Controller

The Remote Controller software AZ490 for controlling NET IMPRESS remotely from a PC is available for an additional order. This Remote Controller has a function to set up and confirm parameters besides the remote control capability. With the Remote Controller, you can set up and modify parameters including the following.

- MCU Type:           Name of a target microcomputer  
                          The name of a target microcomputer displayed on the LCD of NET IMPRESS can be customized.
- Flash ROM Area:   Flash memory area of a target microcomputer
- ROM Block:         Flash memory block alignment can be set up with address and size for each ROM group, enabling you to use the Control Module with derivative microcomputers.
- MCU Clock:         MCU clock frequency
- Communication Interface:   Communication interface with a target system
- Other:              Microcomputer-specific information defined by the Control Module

### 8.3 How to Modify Parameters Using Remote Controller Software (AZ490)

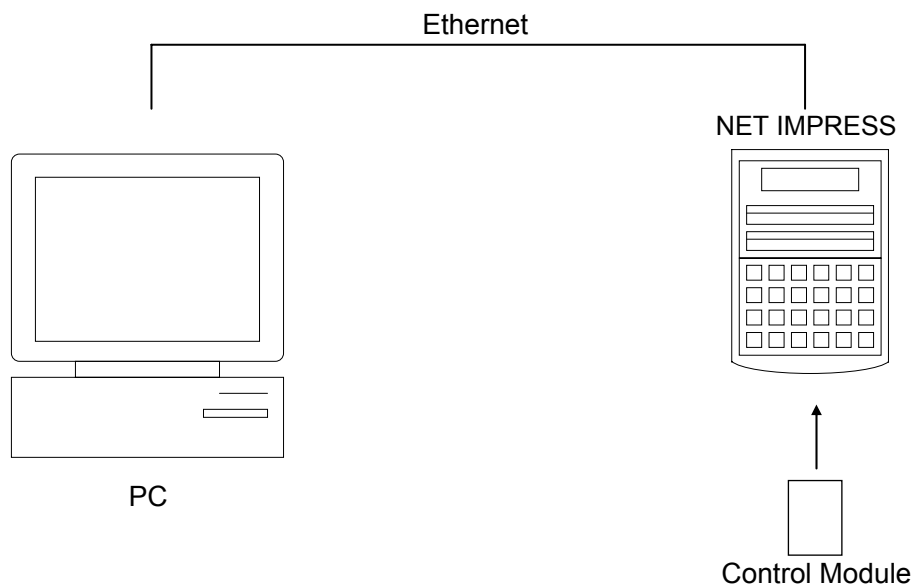

Connect a PC and NET IMPRESS using an Ethernet cable (10BASE-T/100BASE-TX).

Insert the Control Module supporting the target microcomputer into the NET IMPRESS' card slot.

By running the Remote Controller on a PC, you can check or modify parameter tables of the Control Module inserted in NET IMPRESS.

With the Remote Controller AZ490, you can load and save parameters all at once. By saving parameter information generated with the Remote Controller in a PC, you can easily modify parameter tables for various derivative microcomputers of the same family.

Also, using this function, you can easily load the Micom Pack, which you download from our Web site, into the Control Module.

---

## 9 Replacing Definition Program

---

### 9.1 Overview

The Control Module has the function to support programming microcomputers that have different programming specifications from those of the target microcomputer. You can quickly replace the definition program using the definition program download function of the Remote Controller AZ490, instead of changing the Control Module. With this definition program replacement function, you can replace with other Control Module to program microcomputers of different programming specifications by adding the definition program license to the Control Module. The definition program license is available for your additional order. For any questions, contact your local distributor or us.

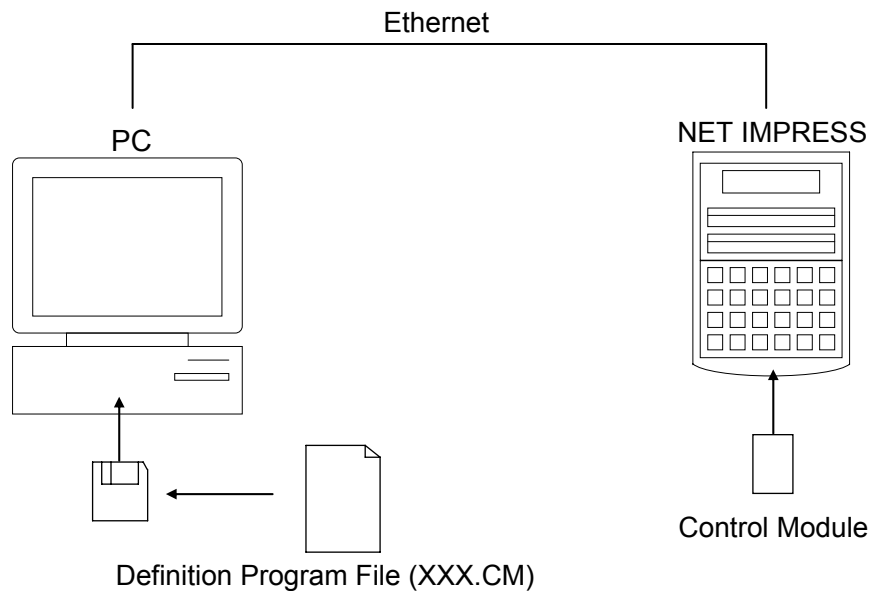

## 9.2 How to Replace Definition Program

By setting the Control Module added with a definition program license into NET IMPRESS, you can replace the definition program of the Control Module using the definition program download function of the Remote Controller AZ490 (Load Definition Program button on the File Transfer tab). (Note that you cannot use this function if you are using NET IMPRESS as stand-alone.) When you purchase the definition program license, download the definition program file (“xxx.CM”), which is in the floppy disk provided with the definition program license, into the Control Module by using this function.

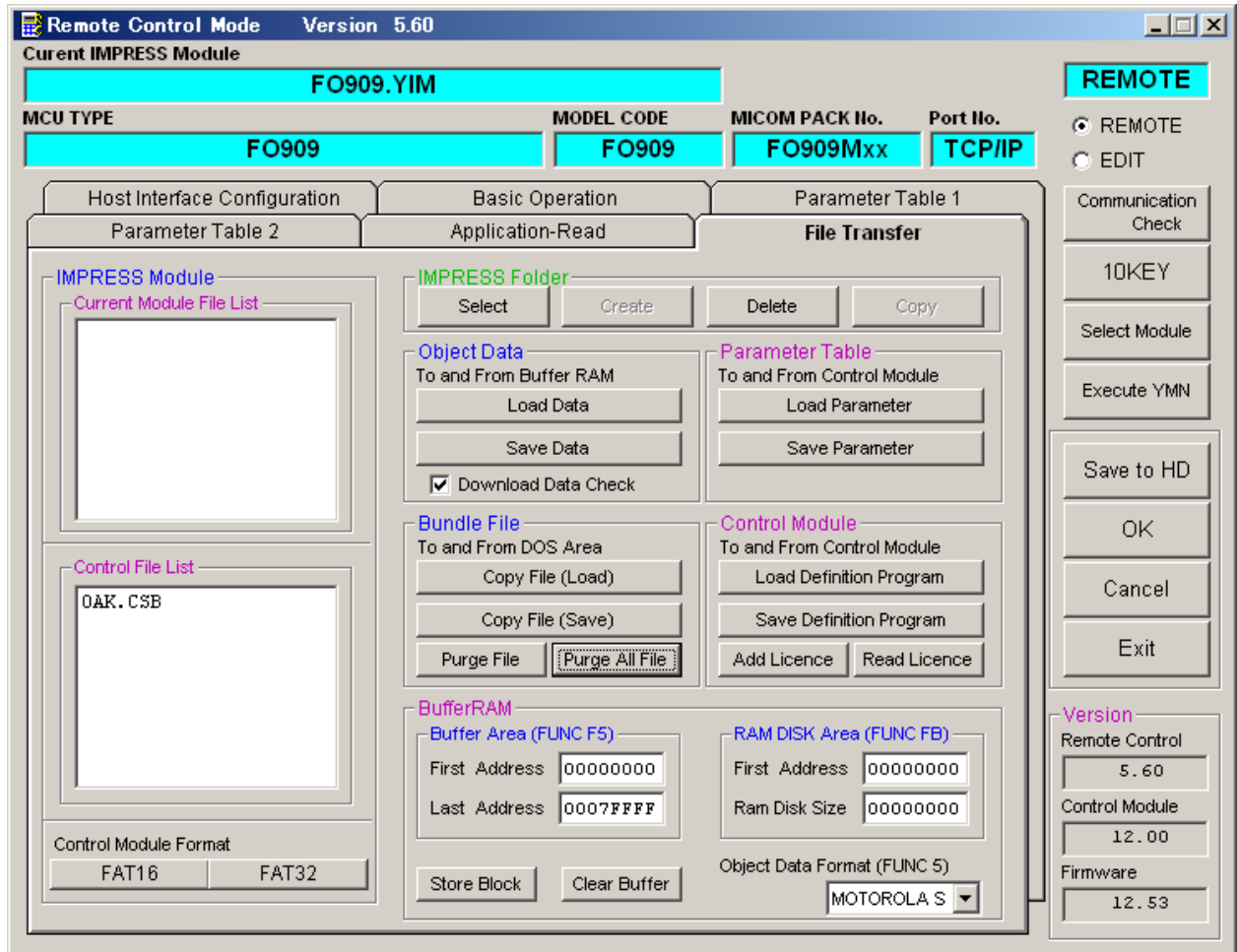

---

## 10 Notes and Cautions for Using Control Module

---

- (1) The Control Module FO909 is built for NET IMPRESS. *DO NOT* use this Control Module for any flash microcomputer programmers other than NETIMPRESS series.
- (2) The Control Module FO909 is designed for the specific microcomputer. Do not use this Control Module for programming microcomputers other than the specified microcomputer. Using this Control Module for microcomputers other than the specified microcomputer would damage your target system.
- (3) NET IMPRESS consumes power of several mA from TVCC1 terminal to drive the interface IC with the target system (IC inside JTAG Adapter).
- (4) *Be sure NOT to* initialize (format) the Control Module (Compact Flash Card). The Control Module contains the definition program (the control program), besides the DOS area where you can save your files. Initializing the Control Module results in destroying this control program.
- (5) *DO NOT insert or remove* the Control Module while the Device Functions or the Function key operation is being executed. Be sure not to insert or remove the Control Module from the flash microcomputer programmer while accessing it.
- (6) Use NET IMPRESS with the Control Module inserted into it.

## 11 Appendix

In this chapter contents of profile register (HEX image data) displayed during execution of the Device Function, FUNC 83.

	11	10	9	8	7	6	5	4	3	2	1	0
FrontCapture	c_back	strage<3:0>			sector<2:0>			00	0	1		
BackCapture		trans<1:0>	0	seq_opt	seqm	fwack	nextm	00	mode<1:0>			

c_back	Current setting value of u_back
strage <3:0>	Memory size of flash
sector <2:0>	Sector size which is the unit of writing and reading data
trans <1:0>	Unit of data transfer via DR register
seqm	When seqm is "0", security is set on flash core and read data from flash are all "0" regardless of the actual content. In addition, no operation except erasing can be done on flash memory.
seq_opt	This bit has no meaning for microcomputers supported by this control module.
nextm	This bit has no meaning for microcomputers supported by this control module.
mode <1:0>	Protocol mode of data transfer to flash core This control module supports only mode 2.
fwack	Flag to indicate that access to flash blocks of MCU core is stopped when fwbsy is "1".



### Memory Size

strage <3:0>	Memory size (Byte)
0000	64K
0001	128K
0010	192K
0011	256K
0100	384K
0101	512K
0110	1024K
0111	2048K
Others	Undefined

### Memory Allocation

divide <1:0>	Number of partitioned ROM data area
00	1
01	2
10	4
11	Undefined

### Transfer Unit

trans <1:0>	Transfer unit (Bit)
00	8
01	16
10	32
11	Undefined

### Mode Assignment

Mode <1:0>	Mode type	Function and method
00	Mode 0	Method of programming and erasing in a sector unit by sector buffer
01	Mode 1	Method of programming in a data transfer unit of DR register
10	Mode 2	Method of programming in a data transfer unit of DR register with SDP function
11	Undefined	—

### Sector/Block Size

Sector <2:0>	Mode 0	Mode 1	Mode 2
	Sector size (Byte)	Block size (Byte)	Sector size (Byte)
000	128	4 K	256
001	256	8 K	512
010	512	16 K	1024
011	1024	Undefined	2048
100	Undefined	Undefined	4096
101	Undefined	Undefined	8192
110	Undefined	Undefined	16384
111	Undefined	Undefined	32768